

Z 722

C106 GS41 M40 MOTORE - MOTOR

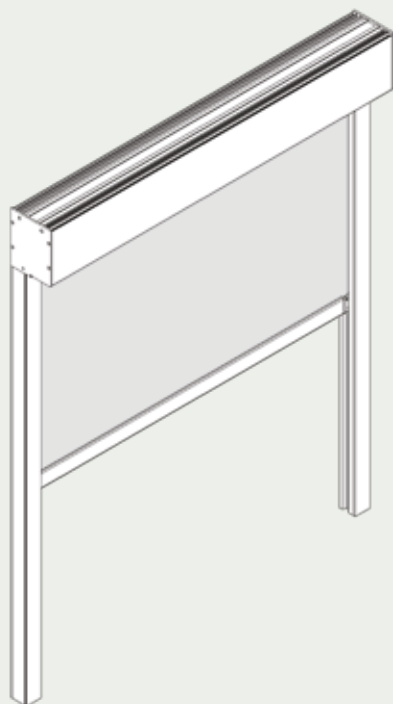

dimensioni espresse in mm  
dimensions shown in mm

C106

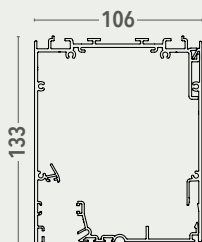

RULLO TUBE

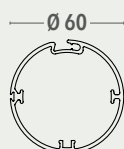

FZ37



GS41

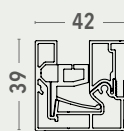

PROFILO CHIUSURA PER INCASSO  
OPTIONAL COVER FOR ENCASEMENT

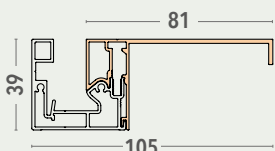

### VARIANTI - OPTIONAL

- profilo anti-pioggia in PVC (bianco, grigio, nero) per fondale FZ37  
PVC waterproof strip (white, grey, black) for FZ37 hem bar

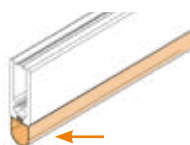

### CARATTERISTICHE - CHARACTERISTICS

- Tipo di applicazione:** verticale - *Application:* vertical
- Ambiente di applicazione:** interno/esterno - *Installation:* indoor/outdoor
- Cassonetto:** squadrato C106 in alluminio estruso composto da una parte fissa e due parti mobili ispezionabili, una anteriore e l'altra di chiusura per permettere il completo riavvolgimento al suo interno del rullo compreso di fondale; coppie di testate autoportanti o per attacco laterale in alluminio verniciato in tinta con il cassonetto  
*Headbox:* C106 extruded aluminum headbox with two removable covers and powder coated aluminum end cheeks that permit the box to be fitted directly to the side channels or end cheeks for side mounting. The headbox allows to hide the tube including hem bar when shade is completely wrapped.
- Rullo di avvolgimento:** Ø 60 mm in alluminio estruso con ogiva per facilitare la manutenzione del telo  
*Roller tube:* Ø 60 mm extruded aluminum tube with slot to facilitate fabric removal
- Guida:** GS41 con profilo di chiusura in alluminio estruso e anima interna con alette in PVC per un perfetto scorrimento e trattenimento del telo in guida, dispositivo brevettato n°102018000007221. Profilo di chiusura per guida a incasso a supplemento. Le guide del sistema ZIP garantiscono oscuramento ove richiesto  
*Side channels:* GS41 extruded aluminum side channels in two parts with winged inner rail in PVC, patent n°102018000007221. Side channel cover for encasement on request. The ZIP system ensures smooth operation keeping the fabric inside the channels and provides blackout where required
- Fondale:** a scomparsa FZ37 piatto in alluminio estruso zavorrato con profilo in ferro zincato, completo di tappi scorrevoli in PVC e spazzolino. A richiesta profilo in gomma anti-pioggia (bianco, grigio, nero) che rimane visibile fuori dal cassonetto  
*Hem bar:* FZ37 retractable extruded aluminum weighted flat hem bar with PVC end caps and brush. PVC waterproof strip (white, grey, black) on request; it remains visible outside the headbox
- Manovra:** a motore tubolare monofase 230V/50Hz M40, completo di fine corsa meccanico e cavo di alimentazione, protezione termica, indice di protezione agli spruzzi d'acqua IP44. Interruttore escluso  
*Operation:* motorised operation; 230V/50Hz M40 tubular motor, with top/bottom limit switches and mains cable, thermal cut-out and class IP44 water resistance. Switch excluded
- Fissaggio guida:** frontale o laterale - *Side channels mounting:* wall or mounting in recess
- Fissaggio cassonetto:** autoportante in guida o con testate per attacco laterale  
*Headbox mounting:* box self supporting on side channels or side mounting of the headbox

### COLORI STANDARD - STANDARD COLOURS

	bianco Ral 9010 - white Ral 9010		grigio Ral 7016 opaco - matt grey Ral 7016
	bianco Ral 9016 opaco - matt white Ral 9016		grigio micaceo liscio - smooth micaceous grey
	avorio Ral 1013 - ivory Ral 1013		nero Ral 9005 opaco - matt black Ral 9005
	marrone Ral 8017 - brown Ral 8017		argento anodizzato - silver anodised

### TESSUTI ABBINABILI - SUITABLE FABRICS

- Consultare la **TABELLA A - UTILIZZO TESSUTO** nella sezione tessuti  
Consult **TAB A - FABRICS** in fabric section

### SUPPLEMENTI - SUPPLEMENT per info e automatismi for info and automatic control pag. 458



### NOTE - NOTES

- Motore meccanico M40 - *M40 mechanical motor*
- Tenda motorizzata fornita senza interruttore - *Blind supplied without switch*
- La guida GS41 non consente l'utilizzo di teli finestrati  
*GS41 side channel is not suitable for fabrics with transparent windows*
- Fondale a completa scomparsa nel cassonetto, non visibile dall'esterno  
*Hem bar completely disappearing into the box, not visible from the outside*

### ➔ NUOVO CASSONETTO C106 NEW C106 HEADBOX

- Particolare del nuovo cassonetto zip C106 con fondale FZ37 a "scomparsa", completamente alloggiato al suo interno una volta avvolta la tenda.

*New C106 headbox with FZ37 retractable hem bar which is totally hidden inside the headbox when shade is completely wrapped*

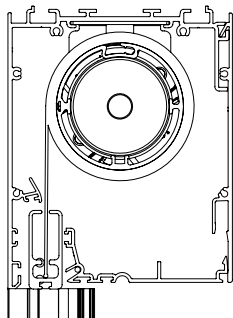

### GUIDA GS41 GS41 SIDE CHANNEL

- Particolare di GS41 con profilo di chiusura e anima interna con linguetta in PVC (brevetto n°102018000007221) per un perfetto scorrimento e trattenimento in guida del telo e, ove richiesto, un effetto oscuramento

*GS41 side channels with cover and winged inner rail in PVC (patent n°102018000007221): the ZIP system ensures smooth operation keeping the fabric inside the channels and provides blackout where required*

